

BEFORE YOU BEGIN, READ ALL WARNINGS AND INSTALLATION INSTRUCTIONS AND SAVE FOR FUTURE USE.

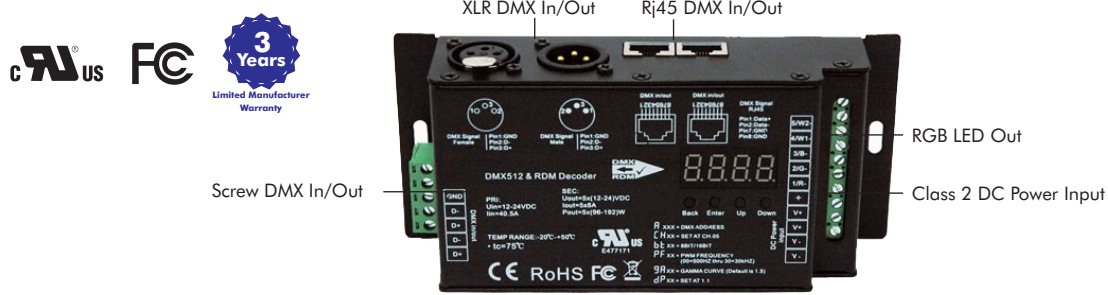

SAFETY & WARNINGS

This product is intended to be installed and serviced by a qualified licensed electrician. Install in accordance with the National Electric Code, and local regulations. Disconnect power before installing or servicing. **Only power with a regulated (listed) constant voltage Class 2 power supply (12-24V DC). Never use this product with dimmable or magnetic dimmable power source(driver).**

Ensure applicable wire is installed between driver, fixture, and any controls in between. When choosing wire, factor in voltage drop, amperage rating and type (in-wall rated, wet location rated, etc.). Inadequate wire installation could overheat wires and cause fire.

This product is rated for indoor installation and only for dry locations. Avoid direct sun light.

Do not modify this product beyond the instructions in this guide or the warranty will be voided.

Wiring diagrams in this installation guide for basic installations. Please carefully review your installation before proceeding.

PRODUCT FEATURES

- DMX 512 RDM decoder, RDM function can inter-communicate between DMX master and decoder. e.g. you can set DMX decoder's address by DMX master console.
- Metal housing, digital display for address data, easily to set and show DMX address
- Multiple DMX in/out ports: RJ 45, XLR , normal screws
- Total 5 PWM output channels, common anode. Adjustable DMX channel quantity from 1CH~5CH
- Adjustable PWM output resolution ratio 8bit , 16bit.
- Adjustable output PWM frequency from 500HZ ~ 9K HZ
- Adjustable output dimming curve gamma value from 0.1 ~ 9.9
- Adjustable decoding mode

PRODUCT PARAMETER

Part No.	H-DMX2108A-5M-3
Input Voltage	DC 12V~DC 24V (Use only with Class 2 regulated Power supply)
Output Current	5 x 8A
Output Power	5 x (96~288)W

PRODUCT DIMENSION

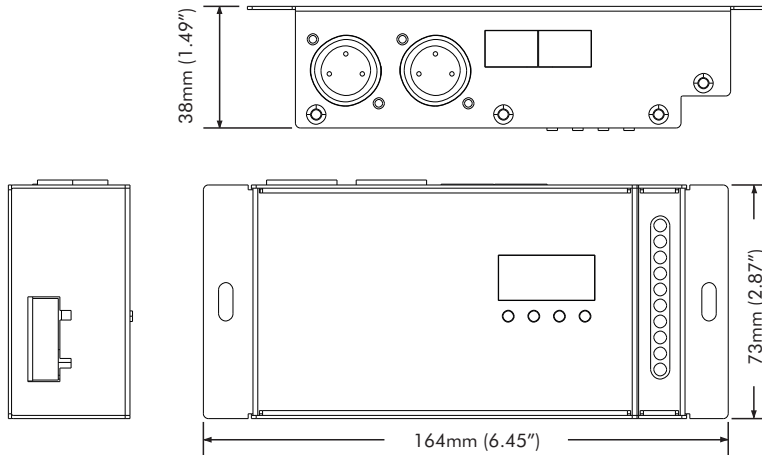

OPERATION

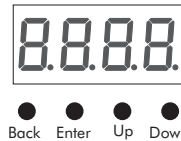

1. DMX address setting

Select menu **8.XXX** click button "Enter" and hold, display flashes, then click or hold button "Up/Down" to set DMX address (click to slow, hold is fast), then click button "Back" to confirm.

2. DMX channel quantity setting

Select menu **8.8.XX** click button "Enter", display flashes, then click button "Up/Down" to set DMX channel quantity, then click button "Back" to confirm.

e.g. The DMX address is already set 001

Ch01 = 1 DMX address for all the output channels, which are all address 001

Ch02 = 2 DMX addresses, output 1 & 3 is address 001, output 2, 4 & 5 is address 002

Ch03 = 3 DMX addresses, output 1, 2 is address 001, 002 output 3, 4 & 5 is address 003

Ch04 = 4 DMX addresses, output 1, 2, 3 is address 001, 002, 003 output 4 & 5 is address 004

Ch05 = 5 DMX addresses, output 1, 2, 3, 4, 5 is address 001, 002, 003, 004, 005

3. PWM output resolution Bit setting

Select menu **8.8.XX** click button "Enter", display flashes, then click button "Up/Down" to choose 08 or 16 bit, then click button "Back" for confirm.

Button Introduction

Up, Down button is for menu selection. After power on the decoder, if keep on clicking Up button you will find below menu on display.

8.XXX Means DMX address. factory defaults setting is 001.

8.8.XX Means DMX channels quantity. factory defaults setting is Ch05

8.8.XX Means Bit (8bit or 16bit). factory defaults setting is 16bit

8.8.XX Means output PWM frequency. factory defaults setting is 1K HZ

8.8.XX Means output PWM frequency. factory defaults setting is 1K HZ

8.8.XX Means Decoding mode, factory defaults setting is dp1.1

By holding button Back + Enter together at the same time over 5 seconds until the display go off, it will restore default settings.

HUEDA™ 5CH RDM DMX512 Decoder

Model : H-DMX2108A-5M-3

Warning: Input voltage must be identical to output voltage of the LED Fixture!

WIRE 6-8 MM (0.25-0.30")







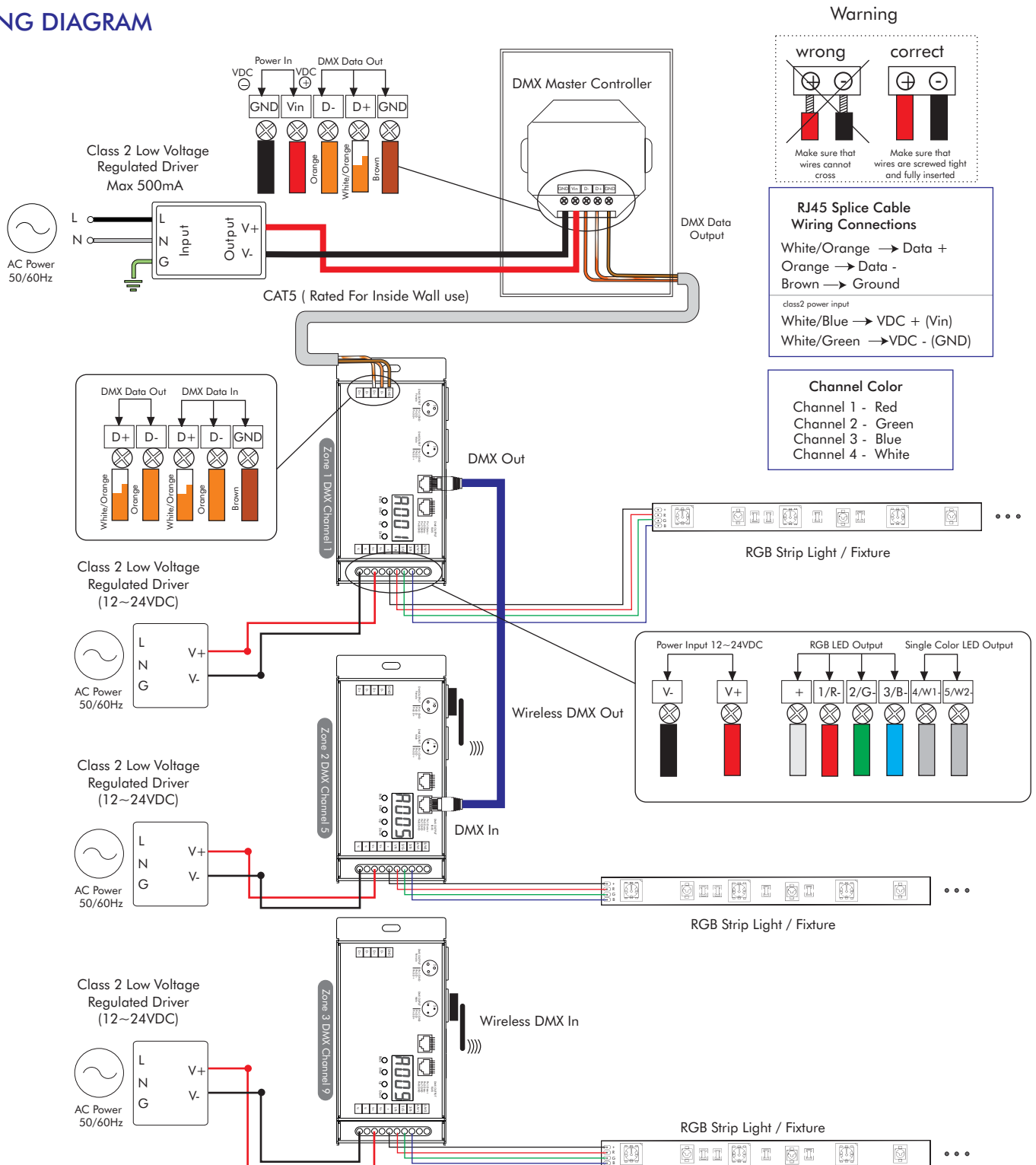



Exposed wire should not be more than 6- 8 mm long & solder tip (tinned). Do not allow Wires to cross and insure all exposed wire is fully inserted into the screw terminals. Hand tighten screw terminals. Use 22 to 14 AWG gauge wire for output terminals.

- Input Voltage must be identical to output voltage of the LED
- Input: For low voltage power input (12VDC ~ 24VDC). V- and V+. Use only 22 to 14 gauge wire for input terminals.

WIRING DIAGRAM



COMPATIBLE MASTER COLOR CONTROLLERS AND CONTROLLERS/RECEIVERS

Master Color Controller / Controllers/Receivers	HUEDA™ (LW-2814DMX)   IOS app available 	HUEDA™ Hub (H-2818WIN)   IOS app available 	RGBW & Dim Control Remote (H-2858Z4) 
RF RGBW Receiver (H-R009PD) 	 *Requires HUEDA™ Hub (H-2818WIN) to use mobile app		
RF RGBW Receiver (Outdoor) (H-R009FA(W)) 	 *Requires HUEDA™ Hub (H-2818WIN) to use mobile app		
5CH DMX Decoder (H-DMX2108A-5M-3) 			
Easy DMX512 Decoder (H-2102B(W)) 			

OUTPUT PWM FREQUENCY SETTING

Select menu **88.XX** click button "Enter", display flashes, then click button "Up/Down" to choose 00~09, then click button "Back" to confirm, 00=500Hz, 01=1kHz, 02=2kHz.....09=9kHz

OUTPUT DIMMING CURVE GAMMA VALUE SETTING

Select menu **88.XX** click button "Enter", display flashes, then click or hold button "Up/Down" to choose 0.1~9.9, then click button "Back" to confirm.

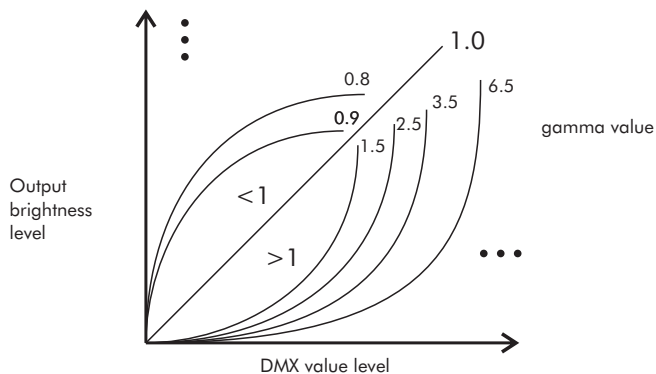

DMX DECODING MODE SETTING:

Select menu **88.XX** click button "Enter", display flashes, then click or hold button "Up/Down" to choose the decoding mode, then click button "Back" to confirm.

DMX address is 001, Ch01

DMX Console Slider number	dp1.1	dp2.1
DMX channel		
1	for all output Dimming	for all output Dimming
2	No use	for all output micro dimming

DMX address is 001, Ch02

DMX Console Slider number	dp1.1	dp2.1	dp3.2
DMX channel			
1	for output 1 & 3 dimming	for output 1 & 3 dimming	for output 1&3 dimming
2	for output 2,4 & 5 dimming	for output 1&3 microdimming	for output 2,4 & 5 dimming
3		for output 2,4 &5 dimming	for all output dimming
4		for output 2,4&5 micro dimming	

DMX address is 001, Ch03

DMX Console Slider number	dp1.1	dp2.1	dp4.3	dp5.3
DMX channel				
1	for output 1 dimming	for output 1 dimming	for output 1 dimming	for output 1 dimming
2	for output 2 dimming	for output 1 micro dimming	for output 2 dimming	for output 2 dimming
3	for output 3,4 & 5 dimming	for output 2 dimming	for output 3,4&5 dimming	for output 3,4&5 dimming
4		for output 2 micro dimming	for all output master dimming	for all output master dimming
5		for output 3,4 & 5 dimming	for all output dimming	strobe effects
6		for output 3,4&5 micro dimming		

DMX address is 001, Ch04

DMX Console Slider number	dp1.1	dp2.1	dp5.4	dp6.4
DMX channel				
1	for output 1 dimming	for output 1 dimming	for output 1 dimming	for output 1 dimming
2	for output 2 dimming	for output 1 micro dimming	for output 2 dimming	for output 2 dimming
3	for output 3 dimming	for output 2 dimming	for output 3 dimming	for output 3 dimming
4	for output 4&5 dimming	for output 2 micro dimming	for output 4&5 dimming	for output 4&5 dimming
5		for output 3 dimming	for all output master dimming	for all output master dimming
6		for output 3 micro dimming		strobe effects
7		for output 4 &5 dimming		
8		for output 4&5 micro dimming		

DMX address is 001, Ch05

DMX Console Slider number	dp1.1	dp2.1	dp6.5	dp7.5
DMX channel				
1	for output 1 dimming	for output 1 dimming	for output 1 dimming	for output 1 dimming
2	for output 2 dimming	for output 1 micro dimming	for output 2 dimming	for output 2 dimming
3	for output 3 dimming	for output 2 dimming	for output 3 dimming	for output 3 dimming
4	for output 4 dimming	for output 2 micro dimming	for output 4 dimming	for output 4 dimming
5	for output 5 dimming	for output 3 dimming	for output 5 dimming	for output 5 dimming
6		for output 3 micro dimming	for all output master dimming	for all output master dimming
7		for output 4 dimming		strobe effects
8		for output 4 micro dimming		
9		for output 5 dimming		
10		for output 5 micro dimming		

FEDERAL COMMUNICATIONS COMMISSION (FCC) STATEMENT

This device complies with part 15 of the FCC rules. Operation is subject to the following two conditions:

1. This device may not cause harmful interference, and
2. This device must accept any interference received, including interference that may cause undesired operation.

Note: The manufactures is not responsible for any radio or tv interference caused by unauthorized modifications to this equipment. Such modifications will void the user's authority to operate the equipment and warranty.

THREE YEAR LIMITED WARRANTY

LED WORLD INC. warranties this product for three year (some exceptions may apply) from the date of shipping unless otherwise noted in writing. This warranty is expressly in lieu of all other warranties expressed or implied. Under this Limited Warranty, the obligation of the company is limited to replacing on a prorated basis, at its option, any component found to be defective. This Limited Warranty does not apply to damage caused by buyer or alteration to the product or incorrect power supply. Factory warrantees are covered by the original manufacturer and claims must be submitted to them. Use only with LED World’s regulated class 2 power supply.

LED World Inc. And its providers will never be liable to you or any other person for any indirect, incidental, consequential, special, punitive or exemplary loss or damage arising from, connected with, the purchase of products, including but not limited to loss of data, business, markets, cost of labour, savings, income, profits, use, production, reputation or goodwill, anticipated or otherwise, or economic loss, under any theory of liability (whether in contract, tort, strict liability or any other theory or law or equity), regardless of any negligence or other fault or wrongdoing (including without limitation gross negligence and fundamental breach) by led world inc. Or any person for whom led world inc. Is responsible, and even if led world inc. Has been advised of the possibility of such loss or damage being incurred.

If a product is defective, we will replace the product with similar or identical product or at our option a credit towards a future purchase. To make a claim under this warranty, obtain a return authorization number.